

# MBS

[www.mbs95.com](http://www.mbs95.com)

By DIZY

Mobilier éco-conçu & upcyclé



Collection 2024

**“ Créer une offre  
de mobilier  
s'appuyant sur  
l'économie  
circulaire,  
le design et  
l'écosystème  
local pour  
décarboner les  
aménagements  
d'espaces. ”**

*Raison d'être DIZY*



Entreprise



®

Certifiée

# deZignons un monde durable

Chez DIZY, les matières usagées ça nous connaît !

Nous **dessinons, recyclons et upcyclons** du mobilier pour qu'il dure longtemps, pour limiter l'empreinte carbone et favoriser l'anti-obsolescence programmée.

Nous vous accompagnons sur vos projets en créant des meubles sur-mesure, à partir de déchets, de vos anciens meubles ou de matériaux issus de déconstruction.

Ensemble deZignons un monde durable !

En 2021, DIZY devient la 1<sup>ère</sup> entreprise du secteur de l'ameublement français à être certifiée **B Corp™**. Un label qui certifie les entreprises ayant une contribution positive sur l'environnement et la société, ce qui vient valider notre engagement d'entreprise et nos actions d'ores et déjà mises en place pour rendre le monde plus responsable.



# S O M M A I R E

|                                      |     |
|--------------------------------------|-----|
| <b>QUI SOMMES NOUS?</b> .....        | 2   |
| <b>MOBILIER ÉCO-CONÇU</b> .....      | 10  |
| <b>MOBILIER UPCYCLÉ</b> .....        | 18  |
| <b>NOS SERVICES</b> .....            | 26  |
| <b>NOTRE OFFRE SUR-MESURE</b> .....  | 28  |
| <b>NOS FINITIONS</b> .....           | 32  |
| <b>NOS RÉALISATIONS</b> .....        | 34  |
| HÔTELS, RÉSIDENCES & COLIVING.....   | 36  |
| TÉLÉTRAVAIL & WORKSPACE.....         | 50  |
| BARS & RESTAURANTS.....              | 64  |
| HABITAT.....                         | 82  |
| <b>NOTRE OFFRE</b> .....             | 92  |
| <b>GAMME ESSENTIELLE</b> .....       | 94  |
| BENCHS.....                          | 96  |
| BUREAUX ASSIS-DEBOUT.....            | 102 |
| BUREAU DROIT.....                    | 106 |
| BUREAUX HOMEOFFICE.....              | 110 |
| TABLES DE RÉUNION.....               | 120 |
| CASIERS.....                         | 126 |
| ÉTAGÈRES.....                        | 132 |
| TABLES DE BISTROT.....               | 136 |
| TABLES DE REPAS.....                 | 142 |
| TRÉPIED.....                         | 148 |
| LUMINAIRES.....                      | 152 |
| TABLES D'APPOINT.....                | 158 |
| <b>MONTAGE &amp; ENTRETIEN</b> ..... | 164 |
| <b>ILS NOUS FONT CONFIANCE</b> ..... | 166 |
| <b>CONTACT</b> .....                 | 170 |



# Nos ENGAGEMENTS



## DES PRODUITS SIMPLES & INTEMPORELS

pour rendre le monde  
et vos espaces durables  
avec du mobilier éco-  
conçu



## DES MATÉRIAUX RECYCLABLES, RECYCLÉS & UPCYCLÉS

sur 100% de nos produits  
et emballages. Des  
finitions au rendu unique,  
esthétique et durable



## DURÉE DE VIE PROLONGÉE

avec du mobilier  
anti-obsolescence  
programmée, montable,  
démontable & réparable



## DES PARTENAIRES LOCAUX

100% de nos achats sont  
faits en Europe & 90% de  
nos partenaires se situent  
en France



## PROTÉGER LA NATURE

en contribuant  
activement et  
positivement à la  
sauvegarde de la planète

# Matériaux recyclables, recyclés & upcyclés...

Grâce aux divers partenariats mis en place, nous vous proposons de nombreuses finitions en matériaux recyclés ou upcyclés comme le plastique, les volants de badminton, le bois de réemploi ou les panneaux de particules upcyclés. Des meubles de seconde vie avec une histoire, un rendu unique, esthétique & durable.

Panneaux de bois réemployés et re-stratifiés



Parquet upcyclé



Bois certifié



Coquillages recyclés



Volants de badminton recyclés



Plastique recyclé



# Nos partenaires locaux

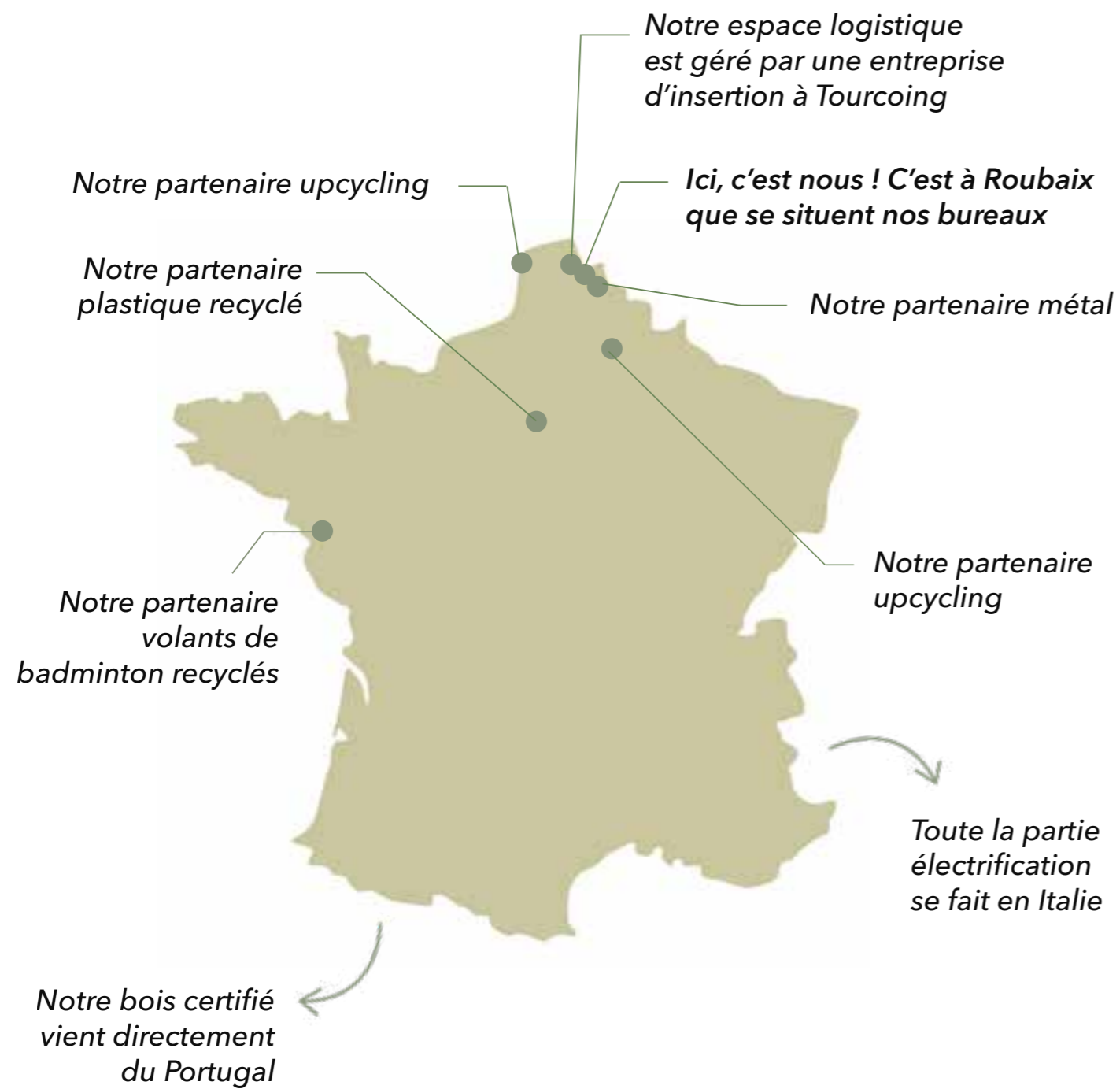

# Mobilier durable

«Ceci n'est pas qu'un bureau...»

C'est un ensemble de pièces montables et démontables qui vous garantissent un meuble réparable, anti-obsolescence programmée.





# Ensemble, protégeons la nature

**CONTRIBUER À LA RESTAURATION  
DES HABITATS NATURELS**

**1 produit DIZY acheté = 1 arbre planté  
dans un programme de reforestation**

En plantant un arbre, nous faisons perdurer nos engagements en participant ensemble à la reforestation du patrimoine forestier français.

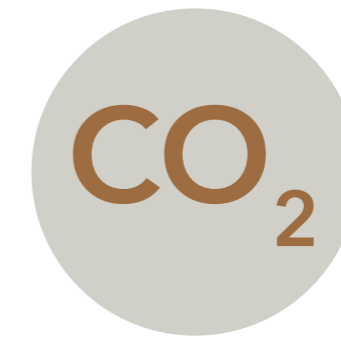

**58.3\***

kg éq. CO2

## **RÉDUIRE NOS ÉMISSIONS**

DeZigner des produits à faible émission en CO2 et mesurer notre impact pour chaque produit vendu.

Nos produits émettent en moyenne **53% de gaz à effet de serre en moins** par rapport au même produit importé sans matière recyclée ni upcyclée.

\* Moyenne du poids carbone des produits DIZY.

Ces résultats d'impact ont été calculés grâce à Waro, une plateforme qui permet aux entreprises de l'ameublement de mesurer, piloter et communiquer les impacts de leurs produits. Les analyses de cycle de vie sont réalisées en suivant le référentiel méthodologique d'évaluation environnemental développé par l'ADEME.

# MOBILIER UPCYCLÉ

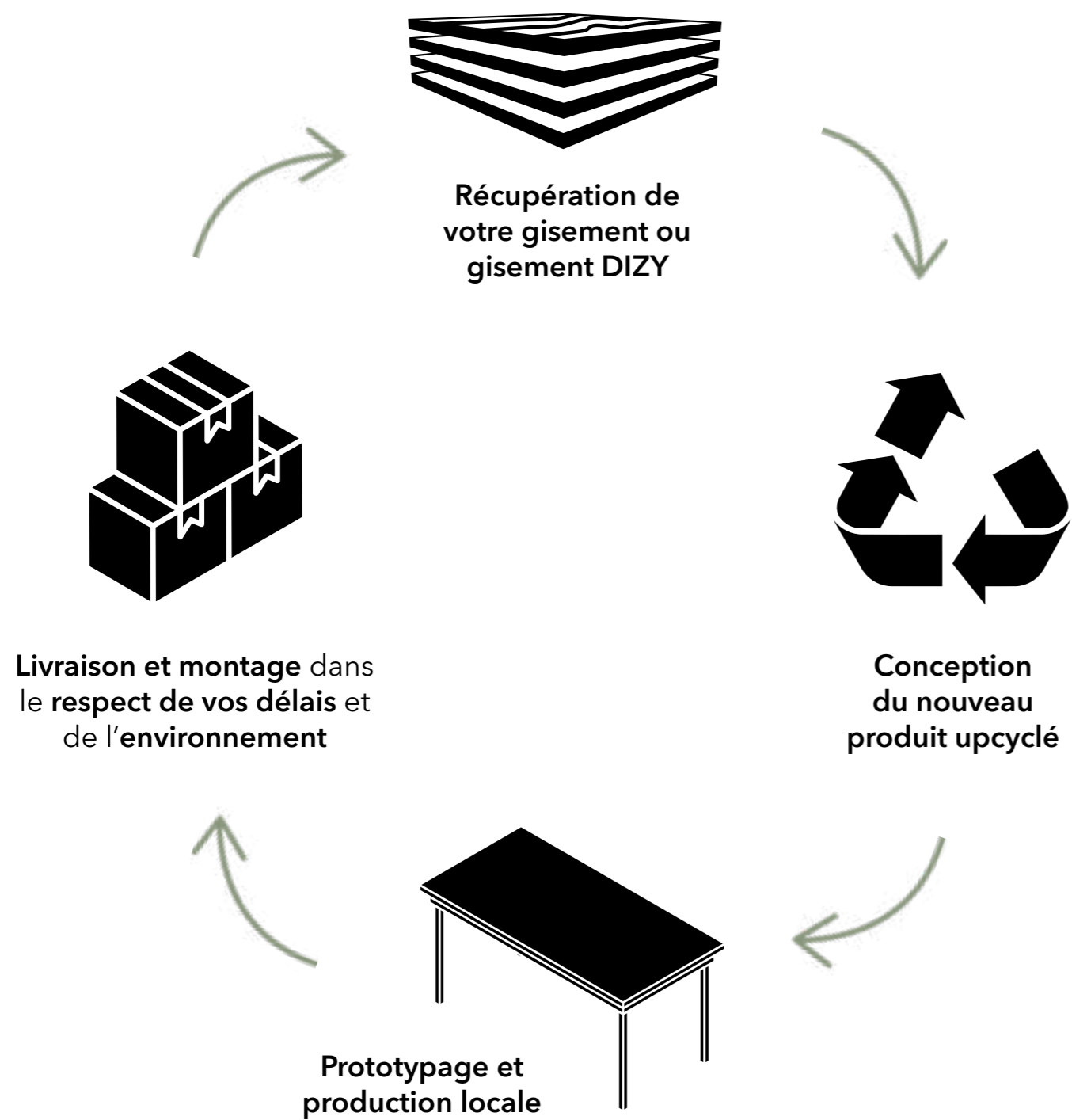



## TABLES RÉALISÉES À PARTIR DE PARQUET UPCYCLÉ !

DIZY | *la maillerie*

DIZY accompagne le projet de promotion & construction La Maillerie / Nhood - reconversion de l'ancien site des 3 Suisses dans le Nord de la France - dans sa démarche d'économie circulaire. A partir de déchets de déconstruction (parquet), DIZY a produit 80 tables basses « cradle-to-cradle ».



## LUMINAIRES RÉALISÉS À PARTIR DE DÉCHETS DE MEUBLES ET DE RAMBARDES D'ESCALIER RECYCLÉES !

DIZY | *Fred Bred*

Dans sa démarche de revalorisation de déchets, DIZY a mobilisé l'artiste Fred Bred pour donner une seconde vie à des pieds de meubles & rambardes d'escalier et donné la liberté à cet artiste Roubaisien de réinterpréter son mobilier pour en faire des œuvres d'art. Fred Bred récupère, découpe, perce, ponce et assemble des morceaux de bois provenant de différentes essences pour transformer le tuteur en une création harmonieuse, authentique et unique.

Une opération 100% locale, éco-responsable et répliquable sur d'autres projets.



## BUREAUX RÉALISÉS À PARTIR DE CHUTES DE PANNEAUX DE LAINE DE ROCHE !

DIZY | 

DIZY a récupéré des chutes de panneaux de laine de roche et en a fait des bureaux. Du pied au plateau, un bureau 100% fabriqué à partir de matériaux de réemploi. Une démarche d'économie circulaire pour un mobilier éco-responsable.

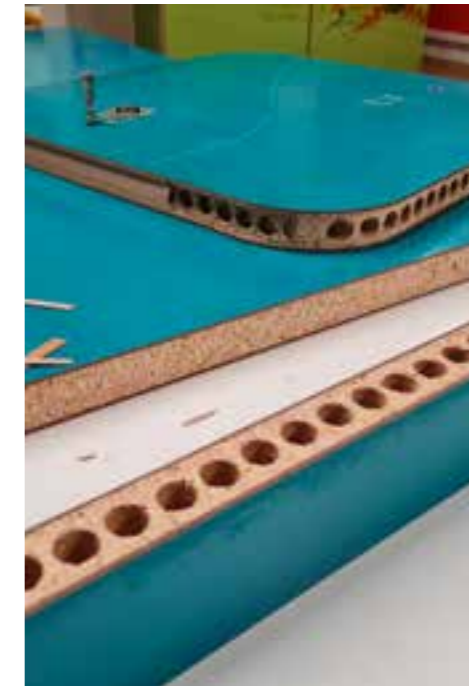

## BUREAUX CRÉÉS À PARTIR DE PORTES PALIÈRES UPCYCLÉES !

DIZY | 



Avec le soutien de Bouygues Bâtiment Nord-Est et dans une démarche d'économie circulaire, DIZY a transformé des portes palières alvéolaires issues d'un chantier de réhabilitation en mobilier éco-responsable. Grâce aux trépieds modulables DIZY, ces portes - démontées, découpées, poncées et vernies - sont devenues des bureaux upcyclés.

## 439 CASIERS CONÇUS À PARTIR D'ANCIENS CAISSONS DE BUREAUX



DIZY a donné une seconde vie aux anciens caissons de bureaux d'une entreprise réaménageant ses locaux. Ces anciens caissons sont devenus des casiers à la charte du client.

Une opération 100% éco-responsable et répliquable sur d'autres projets.



## 310 NOUVEAUX POSTES DE TRAVAIL CRÉÉS À PARTIR D'ANCIENS BUREAUX UPCYCLÉS

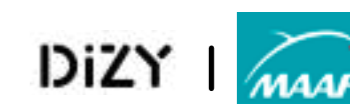

DIZY a donné une seconde vie aux plateaux de bureaux d'une entreprise réaménageant ses locaux. Les anciens bureaux sont devenus des benches avec une nouvelle finition, de nouvelles dimensions et options : trappes d'accès, prise confort, séparateur.



# NOS SERVICES



## PERSONNALISATION & SUR-MESURE

Dimensions, formes, finitions, fonctions... on s'adapte à tous vos besoins pour créer un meuble unique



## ACCOMPAGNEMENT & SERVICE APRÈS-VENTE

Avec un interlocuteur dédié, à votre écoute tout au long de votre projet



## LIVRAISON & MONTAGE

Nous nous chargeons, si vous le souhaitez, de la livraison et du montage dans le respect de vos délais



## MISE À DISPOSITION DE NOS FICHIERS

Fichiers 3D, photos détourées, fiches produits à votre disposition pour intégrer au mieux nos produits à vos projets

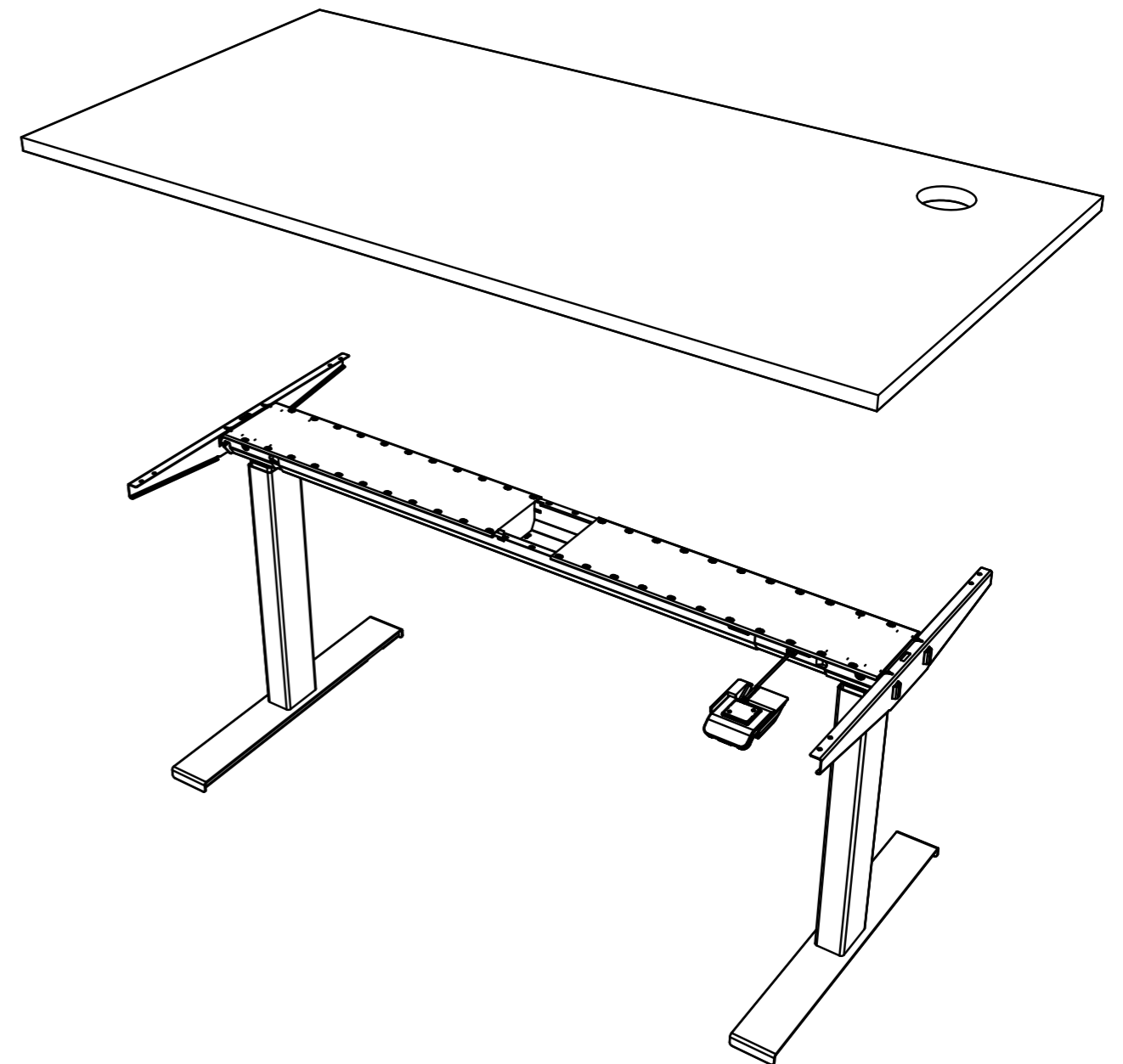



Envie d'un meuble unique  
pour vos espaces?

**OPTEZ POUR LE  
SUR-MESURE !**

---

Besoin de meubles DIZY  
clés en main, éco-conçus  
& livrés rapidement?

**OPTEZ POUR LA  
GAMME  
ESSENTIELLE !**

# SUR-MESURE

Chez DIZY, le sur-mesure c'est s'adapter à vos dimensions et bien au-delà. Formes, coloris, options, tout est possible !



Échange autour de vos besoins en mobilier



Propositions de pistes créatives

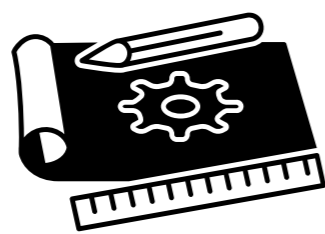

Prototypage et production locale

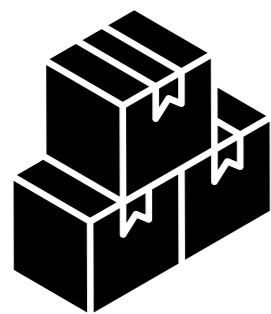

Livraison et montage dans le respect de vos délais et de l'environnement







# NOS FINITIONS

Le plus dur sera de choisir !

## COULEURS STANDARDS



Noir  
9004



Blanc  
9003



Vert  
7033



Terracotta  
8004



Coloris  
Laiton irisé

## & SUR-MESURE

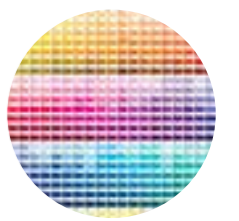

## NOS MATÉRIAUX STANDARDS



Bois certifié  
Chêne massif issu de forêts gérées durablement, 8 coloris disponibles



Parquet upcyclé  
Parquet en bois massif issu de déconstruction transformé en plateaux

## & SUR-MESURE



Coquillages recyclés

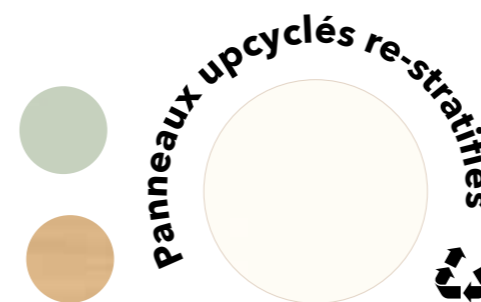

Panneaux upcyclés re-stratifiés  
Un rendu lisse et uniforme de la couleur de votre choix



Volants de badminton recyclés  
A la fois sobre et atypique laissant apparaître les composants d'un volant



Plastique recyclé



# Nos RÉALISATIONS



**HÔTELS, RÉSIDENCES & COLIVING**









CO LIVING HIFE | Bureau mural & Table à manger coloris sur-mesure



Co LIVING HIFE | Table basse & Table extensible sur-mesure







TÉLÉTRAVAIL & WORKSPACE







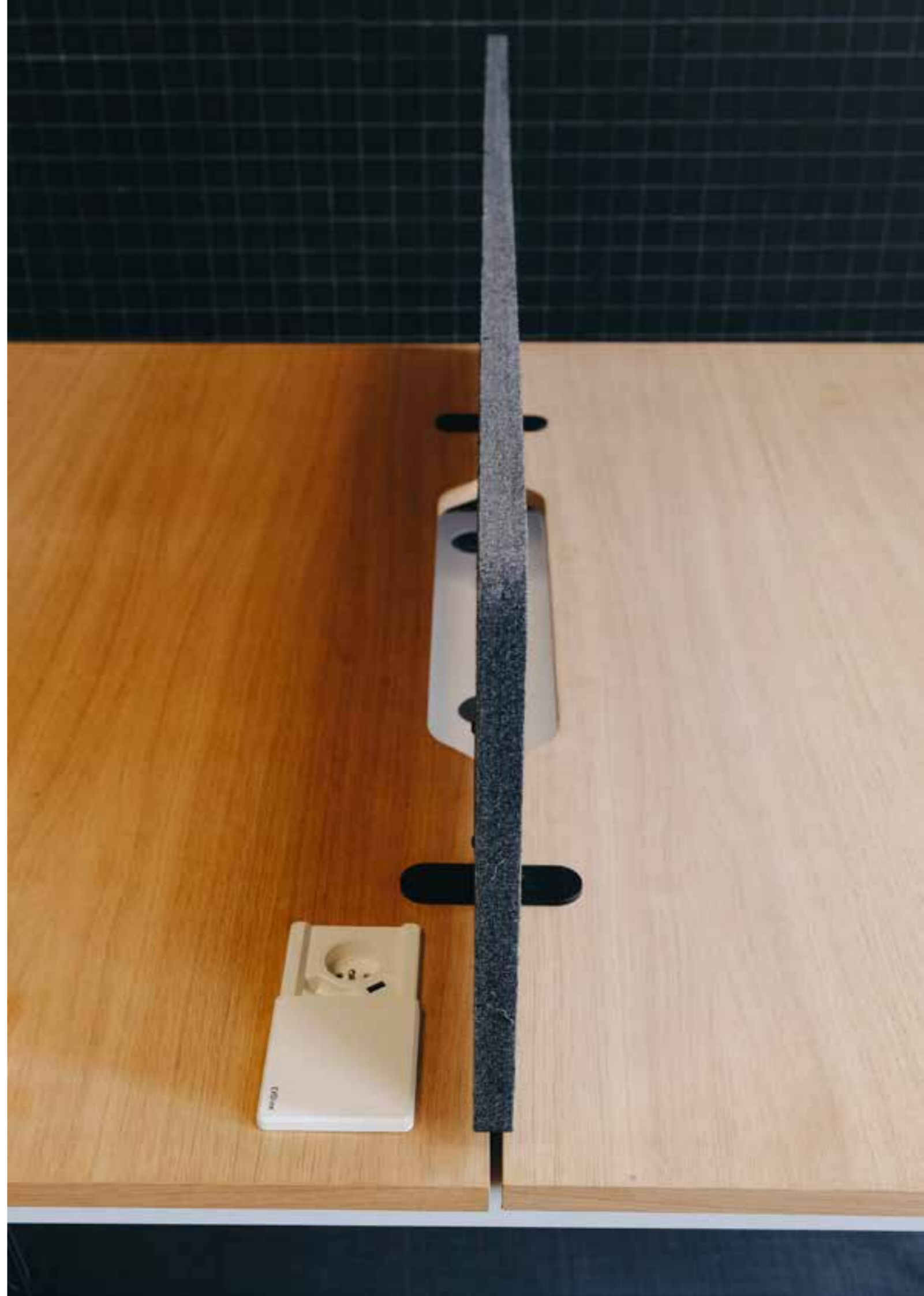









**BARS & RESTAURANTS**

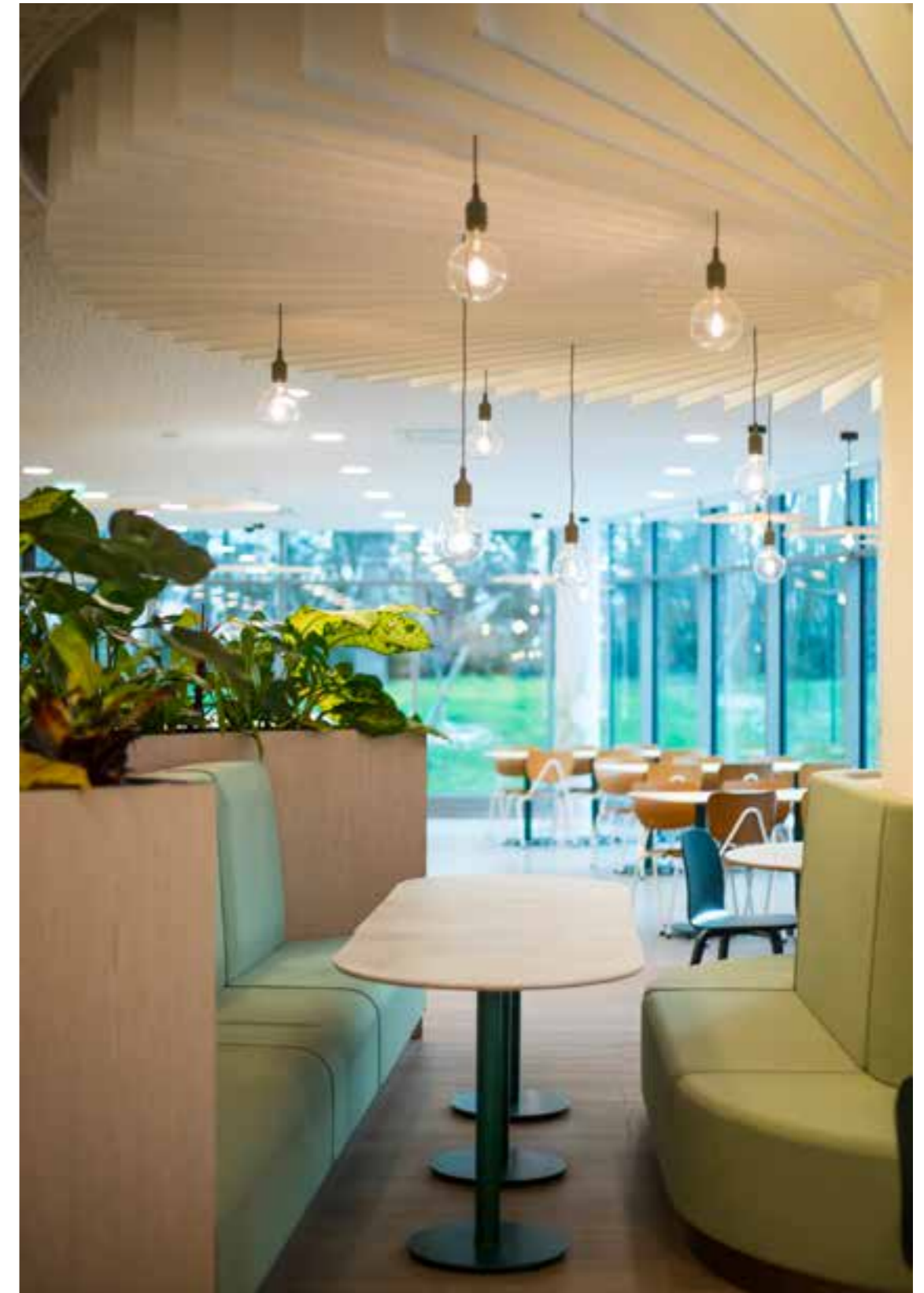





CHEZ  
Simone

CHEZ  
Simone















HABITAT











# GAMME ESSENTIELLE



Page 96 +

**Benches**  
Pour vos espaces de travail



Page 102 +

**Bureaux assis debout**  
Technologie & upcycling



Page 106 +

**Bureau droit**  
Plateau upcyclé re-stratifié



Page 110 +

**Bureaux**  
A personnaliser



Page 120 +

**Tables de réunion**  
Adaptées à vos besoins



Page 126 +

**Casiers**  
Modulables



Page 132 +

**Etagères**  
Pour un rangement optimisé



Page 136 +

**Tables de bistrot**  
Pour tous vos espaces



Page 142 +

**Tables de repas**  
De 1 à 16 personnes



Page 148 +

**Trépied**  
Pour tous vos plateaux



Page 152 +

**Luminaires**  
Petit, moyen ou grand format



Page 158 +

**Tables d'appoint**  
Toujours à portée de main



# Benchs

3 dimensions de plateaux, 9 modèles de benchs



Un plateau de bureau DIZY c'est environ  
20kg de déchets évités et non transportés.  
20kg de nouvelles matières non produites.  
Vous avez la possibilité de choisir  
différentes finitions de plaquage.





**BUREAU SIMPLE**

**BENCH X2**

**BENCH X4**



PLATEAU MÉLAMINÉ UPCYCLÉ RE-STRATIFIÉ BLANC 



PLATEAU MÉLAMINÉ UPCYCLÉ RE-STRATIFIÉ BOIS 

### BUREAU SIMPLE

|             |          |                      |
|-------------|----------|----------------------|
| 118x68x75cm | 399€ HT. | 46kg eq. CO2   -51%* |
| 138x68x75cm | 449€ HT. | 50kg eq. CO2   -51%* |
| 158x68x75cm | 499€ HT. | 54kg eq. CO2   -51%* |

### BENCH X2

|              |          |                      |
|--------------|----------|----------------------|
| 118x138x75cm | 699€ HT. | 68kg eq. CO2   -55%* |
| 138x138x75cm | 749€ HT. | 74kg eq. CO2   -56%* |
| 158x138x75cm | 799€ HT. | 86kg eq. CO2   -54%* |

### BENCH X4

|              |           |                       |
|--------------|-----------|-----------------------|
| 236x138x75cm | 1249€ HT. | 133kg eq. CO2   -56%* |
| 276x138x75cm | 1299€ HT. | 143kg eq. CO2   -55%* |
| 316x138x75cm | 1349€ HT. | 170kg eq. CO2   -53%* |

# OPTIONS

## SÉPARATEUR ACOUSTIQUE

Coefficient d'absorption de  $\mu 0,9$

349€ HT.

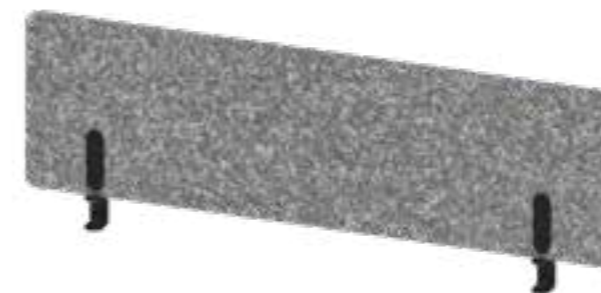

## GOULOTTE

60cm

39€ HT.



## ELECTRIFICATION

Modèle EVOLine Square 80

99€ HT.



Noir



Gris



Blanc

# LES BUREAUX QUI RÉDUISENT L'EMPREINTE CARBONE DE VOS ESPACES DE TRAVAIL

## INDICATEURS D'IMPACTS



Effet de serre  
68kg éq. CO2\*

\* poids carbone du bench x2  
118x138x75cm

## DURÉE DE VIE



Garantie **5 ans**  
Pièces détachées disponibles

## FABRICATION



Sourcing des matières  
premières locales, **100%**  
**Europe**  
Fabrication et assemblage  
**100% en France**

## Composition matières

**49%**  
matières upcyclées

Produit comportant au moins 20% de  
matières issues de réemploi ou de  
la réutilisation - Éligible au sens de  
l'article 13 de la loi AGEC

Ces résultats d'impact ont été calculés grâce à Waro, une plateforme qui permet aux entreprises de l'ameublement de mesurer, piloter et communiquer les impacts de leurs produits. Les analyses de cycle de vie sont réalisées en suivant le référentiel méthodologique d'évaluation environnemental développé par l'ADEME.



# Bureaux assis-debout







Le bureau assis-debout DIZY allie technologie & upcycling. Il possède un pied réglable électroniquement de 62 à 113cm de hauteur. 4 mémoires de position sont disponibles. Ce bureau dispose d'un plateau upcyclé re-stratifié ( finition bois ou blanc) et est 100% compatible Loi AGECE !

**NOUVEAU !**





-  PLATEAU MÉLAMINÉ UPCYCLÉ RE-STRATIFIÉ BLANC 
-  PLATEAU MÉLAMINÉ UPCYCLÉ RE-STRATIFIÉ BOIS 

118x68x75cm  
138x68x75cm  
158x68x75cm

679€ HT.  
689€ HT.  
699€ HT.

59kg eq. CO2 | -44%\*  
60kg eq. CO2 | -46%\*  
61kg eq. CO2 | -47%\*

# OPTIONS

## SÉPARATEUR ACOUSTIQUE

Coefficient d'absorption de  $\mu 0,9$

349€ HT.

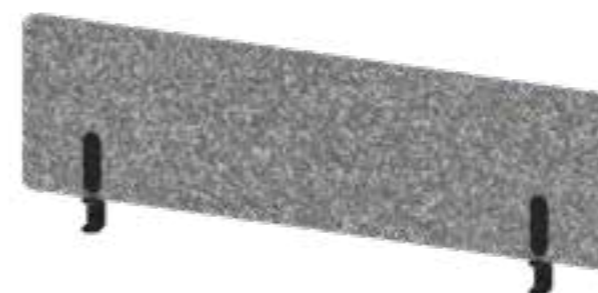

## GOULOTTE

60cm

39€ HT.

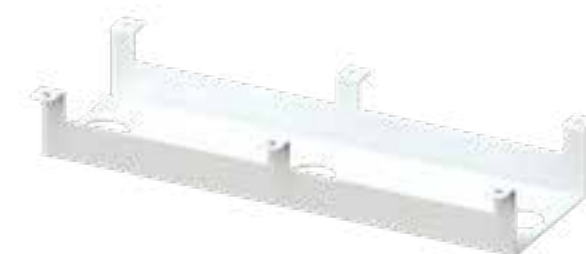

## ELECTRIFICATION

Modèle *EVoline Square 80*

99€ HT.



Noir

Gris

Blanc

# Bureau droit



Le bureau loi AGEC DIZY est comme son nom l'indique un bureau conçu pour respecter le cadre de la loi AGEC grâce à son plateau upcyclé re-stratifié (finition bois ou blanc). Ce bureau à tout petit prix possède également un piètement métal et est disponible avec différentes options.

**NOUVEAU !**





138x68x75cm

299€ HT.

27kg eq. CO2 | -61%\*



PLATEAU MÉLAMINÉ UPCYCLÉ RE-STRATIFIÉ BLANC 



PLATEAU MÉLAMINÉ UPCYCLÉ RE-STRATIFIÉ BOIS 

# OPTIONS

## SÉPARATEUR ACOUSTIQUE

Coefficient d'absorption de  $\mu 0,9$

349€ HT.

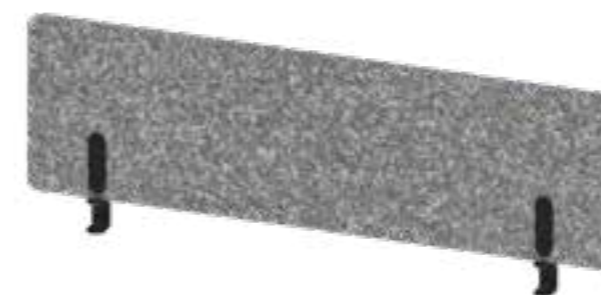

## GOULOTTE

60cm

39€ HT.

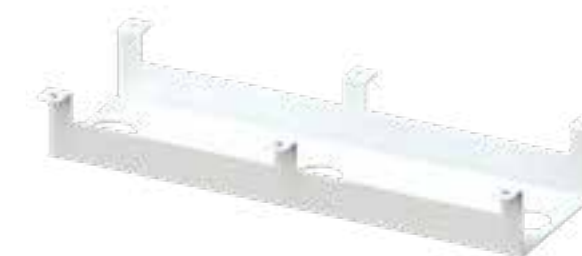

## ELECTRIFICATION

Modèle *EVOline Square 80*

99€ HT.



Noir



Gris



Blanc

# Bureaux en bois certifié



Les bureaux DIZY ont été conçus avec des matériaux éco-responsables de qualité et intègrent tous les éléments essentiels pour travailler confortablement.

## FINITIONS







---

**BUREAU**  
by Fred

Dimensions : 116x65x75cm  
33kg eq. CO2  
Prix HT : 259€



---

**BUREAU TIROIR &  
LAMPE**  
by Désiré

Dimensions : 116x65x75cm  
61kg eq. CO2  
Prix HT : 399€



---

**BUREAU & TIROIR**  
by Marie

Dimensions : 116x65x75cm  
51kg eq. CO2  
Prix HT : 339€



---

**BUREAU TIROIR,  
SÉPARATEUR & LAMPE**  
by Eleonore

Dimensions : 116x65x75cm  
56kg eq. CO2  
Prix HT : 449€



---

**BUREAU & LAMPE**  
by Camille

Dimensions : 116x65x75cm  
50kg eq. CO2  
Prix HT : 329€



---

**BUREAU COMPLET**  
by Adèle

Dimensions : 116x65x75cm  
66kg eq. CO2  
Prix HT : 469€



---

**BUREAU CASIER BOIS**

Dimensions : 116x60x75cm  
74kg eq. CO2  
Prix HT : 649€



---

**BUREAU TÉLÉTRAVAIL**

Dimensions : 90x50x75cm  
29kg eq. CO2  
Prix HT : 449€



---

**BUREAU PIEDS NOIRS**

Dimensions : 116x60x75cm  
45kg eq. CO2  
Prix HT : 459€



---

**BUREAU PRO 140**

Dimensions : 140x70x75cm  
54kg eq. CO2  
Prix HT : 629€



---

**BUREAU MURAL**

Dimensions : 70x45x75cm  
21kg eq. CO2  
Prix HT : 229€



---

**BUREAU PRO 160**

Dimensions : 160x80x75cm  
62kg eq. CO2  
Prix HT : 769€



# OPTIONS

Venez ajouter à votre guise lampe, séparateur, vide-poche, casier... à vos bureaux et tables de réunion... Disponibles en 6 coloris.

## COLORIS



**VIDE POCHE**  
Prix HT : 39€



**LUMINAIRE**  
Prix HT : 99€



**SÉPARATEUR**  
Prix HT : 95€



**SÉPARATEUR  
+ LUMINAIRE**  
Prix HT : 149€



**CASIER**  
Prix HT : 79€



**GOULOTTE**  
Prix HT : 45€



# Tables de réunion



Pratiques, les tables de réunion DIZY ont été pensées pour faciliter le travail de chacun. Les découpes permettent aux utilisateurs d'y ajouter des accessoires pour s'installer et interagir efficacement.

## FINITIONS





### TABLE DE RÉUNION 4 PERSONNES 180X90X75

**NOUVEAU !**

|                              |           |              |
|------------------------------|-----------|--------------|
| Plateau bois certifié        | 1299€ HT. | 98kg eq. CO2 |
| Plateau upcyclé re-stratifié | 1299€ HT. | 44kg eq. CO2 |



### TABLE DE RÉUNION 6 PERSONNES 210X90X75

|                              |           |               |
|------------------------------|-----------|---------------|
| Plateau bois certifié        | 1499€ HT. | 110kg eq. CO2 |
| Plateau upcyclé re-stratifié | 1499€ HT. | 46kg eq. CO2  |



### TABLE DE RÉUNION HAUTE 6 PERSONNES 210X90X105

**NOUVEAU !**

|                              |           |               |
|------------------------------|-----------|---------------|
| Plateau bois certifié        | 1699€ HT. | 128kg eq. CO2 |
| Plateau upcyclé re-stratifié | 1699€ HT. | 64kg eq. CO2  |



### TABLE DE RÉUNION 8 PERSONNES 280X90X75

**NOUVEAU !**

|                              |           |               |
|------------------------------|-----------|---------------|
| Plateau bois certifié        | 1899€ HT. | 132kg eq. CO2 |
| Plateau upcyclé re-stratifié | 1899€ HT. | 60kg eq. CO2  |



### TABLE DE RÉUNION 10 PERSONNES 320X120X75

|                              |           |               |
|------------------------------|-----------|---------------|
| Plateau bois certifié        | 3599€ HT. | 143kg eq. CO2 |
| Plateau upcyclé re-stratifié | 3599€ HT. | 97kg eq. CO2  |



### TABLE DE RÉUNION 16 PERSONNES 490X140X75

|                              |           |               |
|------------------------------|-----------|---------------|
| Plateau bois certifié        | 4999€ HT. | 275kg eq. CO2 |
| Plateau upcyclé re-stratifié | 4999€ HT. | 161kg eq. CO2 |





# OPTION

**CONNECTIQUE**  
*Modèle EVOLine Fliptop 4 prises*

229€ HT.



# Casiers

C'est vous qui composez !



DIZY lance sa gamme de casiers upcyclés pour équiper durablement vos espaces de travail. Des casiers pensés et fabriqués à partir de matériaux recyclables, recyclés et upcyclés.







### CASIER SIMPLE

L40xP42xH40cm



### CASIER DOUBLE

L40xP42xH80cm

### CASIER SIMPLE FINITION STRATIFIÉ BLANC OU CHÊNE CLAIR

|            |          |                        |
|------------|----------|------------------------|
| Sans porte | 159€ HT. | 13,8kg eq. CO2   -29%* |
| Avec porte | 179€ HT. | 14,4kg eq. CO2   -38%* |

### CASIER DOUBLE FINITION STRATIFIÉ BLANC OU CHÊNE CLAIR

|            |          |                        |
|------------|----------|------------------------|
| Sans porte | 199€ HT. | 25,4kg eq. CO2   -29%* |
| Avec porte | 249€ HT. | 26,6kg eq. CO2   -40%* |

### FINITIONS SUPÉRIEURES & SOCLES AVEC PATINS RÉGLABLES



x1 casier 89€ HT.

x2 casiers 139€ HT.

x3 casiers 179€ HT.

# OPTIONS

## FINITIONS PORTES SIMPLES OU DOUBLES

Panneaux upcyclés re-stratifiés



Stratifié EGGER  
chêne



Stratifié EGGER  
blanc



Stratifié EGGER  
vert de gris

## SERRURE À CODE

35€ HT.



## TABLETTE INTÉRIEURE

29€ HT.





# LES CASIERS QUI RÉDUISENT L'EMPREINTE CARBONE DE VOS ESPACES DE TRAVAIL

## INDICATEURS D'IMPACTS



Effet de serre  
14.4kg éq. CO2\*

\* poids carbone du casier simple avec porte

## DURÉE DE VIE



Garantie **5 ans**  
Pièces détachées disponibles

## FABRICATION



Sourcing des matières premières locales, **100% françaises**  
Fabrication et assemblage **100% en France**

## Composition matières

**27%**  
matières upcyclées

Produit comportant au moins 20% de matières issues de réemploi ou de la réutilisation - Éligible au sens de l'article 13 de la loi AGEC

Ces résultats d'impact ont été calculés grâce à Waro, une plateforme qui permet aux entreprises de l'ameublement de mesurer, piloter et communiquer les impacts de leurs produits. Les analyses de cycle de vie sont réalisées en suivant le référentiel méthodologique d'évaluation environnemental développé par l'ADEME.



# Etagères



Les étagères DIZY offrent diverses configurations permettant de s'adapter à tous vos espaces. Les séparateurs intégrés vous permettront de reposer vos livres et structurer au mieux vos envies.

## FINITIONS

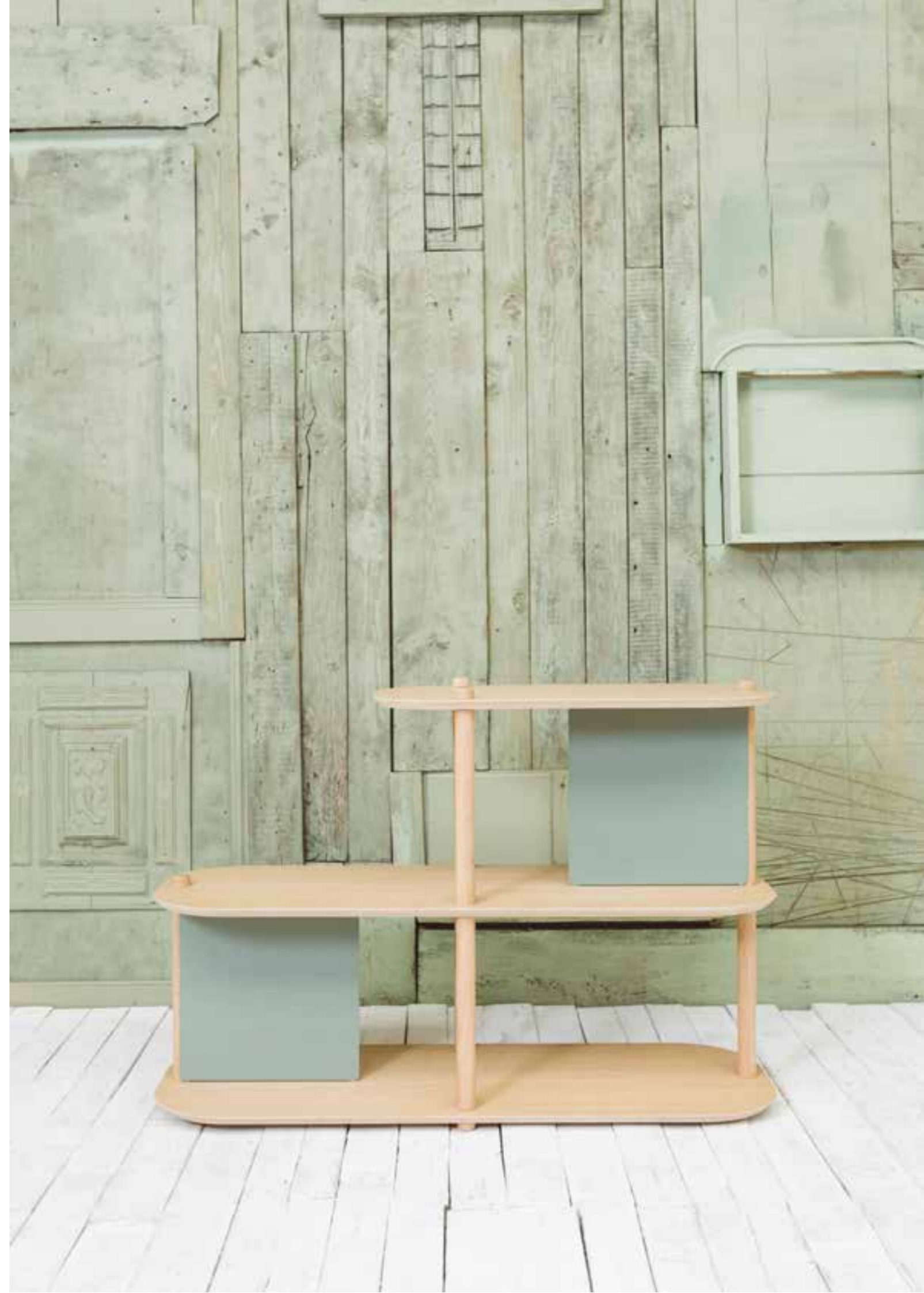



---

**GRANDE ÉTAGÈRE  
2 NIVEAUX**

By Brune

Dimensions : 116x42x43cm

55kg eq. CO2

Prix HT : 349€



---

**GRANDE ÉTAGÈRE  
3 NIVEAUX**

By Théodore

Dimensions : 116x42x78cm

79kg eq. CO2

Prix HT : 479€



---

**GRANDE ÉTAGÈRE  
2 NIVEAUX & DEMI**

By Lou

Dimensions : 116x42x78cm

71kg eq. CO2

Prix HT : 459€



---

**GRANDE ÉTAGÈRE  
4 NIVEAUX**

By Toscane

Dimensions : 116x42x117cm

99kg eq. CO2

Prix HT : 639€

# Tables de bistrot



Les tables de bistrot DIZY se caractérisent par leur pied central en métal, et leurs plateaux interchangeables. Des matériaux soigneusement choisis et un design pensé pour favoriser les moments de partage et les rendre mémorables.



### 3 FORMES - 2 DIMENSIONS

60x60  
ou  
70x70

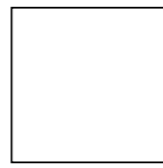
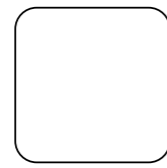
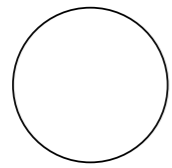

### 2 HAUTEURS

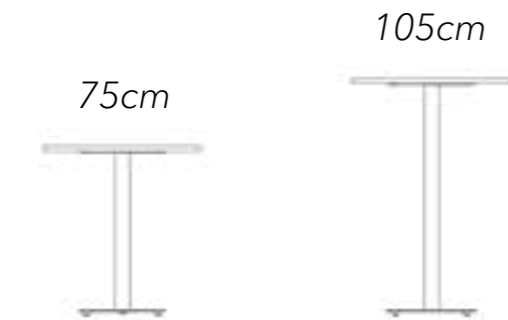



### 2 FINITIONS





AVEC OU SANS CERCLAGE



### 2 FINITIONS DE PIÈTEMENT

-  RAL 9005 NOIR MAT
-  GOLDENBEACH - MAT FINE TEXTURE

### 4 FINITIONS DE PLATEAUX

-  PANNEAUX UPCYCLÉS RE-STRATIFIÉS  
W980 BLANC KAOLIN  
H3157 VICENZA
-  VOLANTS DE BADMINTON RECYCLÉS
-  PARQUET UPCYCLÉ
-  BOIS CERTIFIÉ PLAQUAGE CHÊNE VERNIS



### TABLE DE BISTROT 60X60X75 AVEC CERCLAGE

|                              |          |                        |
|------------------------------|----------|------------------------|
| Plateau bois certifié        | 379€ HT. | 40,6kg eq. CO2   -36%* |
| Plateau volants de badminton | 439€ HT. | 41,9kg eq. CO2   -47%* |

**NOUVEAU !**



### TABLE DE BISTROT 60X60X75 SANS CERCLAGE

|                              |          |                        |
|------------------------------|----------|------------------------|
| Plateau upcyclé re-stratifié | 329€ HT. | 28,5kg eq. CO2   -45%* |
| Plateau bois certifié        | 299€ HT. | 34,4kg eq. CO2   -38%* |
| Plateau volants de badminton | 349€ HT. | 36,7kg eq. CO2   -48%* |
| Plateau parquet upcyclé      | 399€ HT. |                        |

**NOUVEAU !**



### TABLE DE BISTROT 70X70X75 SANS CERCLAGE

|                              |          |                        |
|------------------------------|----------|------------------------|
| Plateau upcyclé re-stratifié | 339€ HT. | 29,4kg eq. CO2   -50%* |
| Plateau bois certifié        | 329€ HT. | 35,2kg eq. CO2   -42%* |
| Plateau volants de badminton | 399€ HT. | 40,8kg eq. CO2   -50%* |
| Plateau parquet upcyclé      | 449€ HT. |                        |

**NOUVEAU !**



### TABLE DE BISTROT HAUTE 60X60X105 SANS CERCLAGE

|                              |          |                        |
|------------------------------|----------|------------------------|
| Plateau upcyclé re-stratifié | 379€ HT. | 32,9kg eq. CO2   -42%* |
| Plateau bois certifié        | 359€ HT. | 35,5kg eq. CO2   -39%* |
| Plateau volants de badminton | 399€ HT. | 38,3kg eq. CO2   -48%* |
| Plateau parquet upcyclé      | 459€ HT. |                        |

**NOUVEAU !**



### TABLE DE BISTROT HAUTE 70X70X105 SANS CERCLAGE

|                              |          |                        |
|------------------------------|----------|------------------------|
| Plateau upcyclé re-stratifié | 399€ HT. | 31kg eq. CO2   -49%*   |
| Plateau bois certifié        | 379€ HT. | 36,8kg eq. CO2   -42%* |
| Plateau volants de badminton | 449€ HT. | 42,4kg eq. CO2   -50%* |
| Plateau parquet upcyclé      | 499€ HT. |                        |

\* Par rapport au même produit importé sans matière recyclée ni upcyclée

# LES TABLES DE BISTROT QUI RÉDUISENT L'EMPREINTE CARBONE DE VOS ESPACES DE TRAVAIL

## INDICATEURS D'IMPACTS



Effet de serre  
32.9kg éq. CO2\*

\*poids carbone de la table de bistrot  
haute 60x60x105 plateau  
upcyclé re-stratifié

## FABRICATION



Sourcing des matières premières  
locales, **100% Europe**  
Fabrication et assemblage **100%**  
**en France**

## DURÉE DE VIE



Garantie **5 ans**  
Pièces détachées disponibles

## Composition matières

**21%**  
matières upcyclées

Produit comportant au moins 20% de  
matières issues de réemploi ou de la  
réutilisation - Éligible au sens de l'article  
13 de la loi AGEC



Ces résultats d'impact ont été calculés grâce à Waro, une plateforme qui permet aux entreprises de l'ameublement de mesurer, piloter et communiquer les impacts de leurs produits. Les analyses de cycle de vie sont réalisées en suivant le référentiel méthodologique d'évaluation environnemental développé par l'ADEME.



# Tables de repas



Les tables de repas DIZY s'adaptent au nombre de vos convives. De 1 à 16 personnes, avec ou sans tiroir pour venir y ranger vos couverts et autres ustensiles.

## FINITIONS







---

**TABLE DE REPAS**

By Jacques

Dimensions : 116x76x75cm

53,9kg eq. CO2

Prix HT : 249€



---

**TABLE DE REPAS & DUO  
DE TIROIRS**

By Héloïse

Dimensions : 116x76x75cm

67,4kg eq. CO2

Prix HT : 419€



---

**TABLE DE REPAS & TIROIR**

By Céleste

Dimensions : 116x76x75cm

64,8kg eq. CO2

Prix HT : 339€



---

**TABLE DÉSAXÉE**

Dimensions : 75x45x75cm

57,4kg eq. CO2

Prix HT : 219€

Dimensions : 80x50x75cm

Prix HT : 249€



### TABLE DE REPAS 4 PERSONNES 180X90X75

**NOUVEAU !**

|                              |           |              |
|------------------------------|-----------|--------------|
| Plateau bois certifié        | 1299€ HT. | 98kg eq. CO2 |
| Plateau upcyclé re-stratifié | 1299€ HT. | 44kg eq. CO2 |



### TABLE DE REPAS 6 PERSONNES 210X90X75

|                              |           |               |
|------------------------------|-----------|---------------|
| Plateau bois certifié        | 1499€ HT. | 110kg eq. CO2 |
| Plateau upcyclé re-stratifié | 1499€ HT. | 46kg eq. CO2  |



### TABLE DE REPAS HAUTE 6 PERSONNES 210X90X105

**NOUVEAU !**

|                              |           |               |
|------------------------------|-----------|---------------|
| Plateau bois certifié        | 1699€ HT. | 128kg eq. CO2 |
| Plateau upcyclé re-stratifié | 1699€ HT. | 64kg eq. CO2  |



### TABLE DE REPAS 8 PERSONNES 280X90X75

**NOUVEAU !**

|                              |           |               |
|------------------------------|-----------|---------------|
| Plateau bois certifié        | 1899€ HT. | 132kg eq. CO2 |
| Plateau upcyclé re-stratifié | 1899€ HT. | 60kg eq. CO2  |



### TABLE DE REPAS 10 PERSONNES 320X120X75

|                              |           |               |
|------------------------------|-----------|---------------|
| Plateau bois certifié        | 3599€ HT. | 143kg eq. CO2 |
| Plateau upcyclé re-stratifié | 3599€ HT. | 97kg eq. CO2  |



### TABLE DE REPAS 16 PERSONNES 490X140X75

|                              |           |               |
|------------------------------|-----------|---------------|
| Plateau bois certifié        | 4999€ HT. | 275kg eq. CO2 |
| Plateau upcyclé re-stratifié | 4999€ HT. | 161kg eq. CO2 |



# Trépied

Pour donner une seconde vie à vos plateaux



Le trépied DIZY, c'est trois pieds fuselés qui s'adaptent aux différents formats de plateaux tout en conservant une grande stabilité & un rendu design.





### LONGUEUR DE PLATEAU

120cm et plus

### LARGEUR DE PLATEAU

de 60 à 95cm

### EPAISSEUR DE PLATEAU

de 2,5 à 5cm

### POIDS CARBONE

31,6kg eq. CO2

### PRIX HT

175€ par pied

### FINITIONS



Innovation  
**bpi**france

Un produit 100% créé dans  
l'optique de donner une  
seconde vie à vos plateaux /  
déchets



# Luminaires



Les luminaires DIZY sont composés d'un pied en chêne massif, d'un abat-jour orientable en métal et d'un câble en lin naturel.

## FINITIONS





---

**PETITE LAMPE**  
by Suzanne

H : 49cm  
16,4kg eq. CO2  
Prix HT : 139€



---

**MOYENNE LAMPE**  
by Thelma

H : 120cm  
21kg eq. CO2  
Prix HT : 179€



---

**GRANDE LAMPE**  
by Thaïs

H : 155cm  
22kg eq. CO2  
Prix HT : 199€





### **PETITE LAMPE**

by Suzanne

Edition 'DIZY by Fred Bred'

H : 49cm

15,5kg eq. CO2

Prix HT : 319€

\* Produit disponible uniquement en noir profond



### **GRANDE LAMPE**

by Thaïs

Edition 'DIZY by Fred Bred'

H : 155cm

21kg eq. CO2

Prix HT : 379€

\* Produit disponible uniquement en Terracotta



### **TABLE D'APPOINT DUO DE PLATEAUX**

by Constance

Edition 'DIZY by Fred Bred'

Dimensions : 50x50x43cm

16kg eq. CO2

Prix HT : 399€

\* Produit disponible uniquement en vert de gris



# DIZY



## Fred Bred



# Tables d'appoint



Les tables d'appoint DIZY sont idéales à placer comme table de chevet ou table d'appoint dans un salon. Pratiques et épurées, elles se fondront parfaitement dans vos espaces.

## FINITIONS







---

**TABLE D'APPOINT  
DUO DE PLATEAUX**  
by Constance

Dimensions : 50x50x43cm  
17kg eq. CO2  
Prix HT : 199€



---

**PETITE TABLE RONDE**  
by Théo

Dimensions : 50x50x43cm  
14kg eq. CO2  
Prix HT : 159€



---

**TABLE D'APPOINT  
DUO DE PLATEAUX**  
by Constance

*'Edition volants recyclés'*  
Dimensions : 50x50x43cm  
15kg eq. CO2  
Prix HT : 279€



---

**PETITE TABLE RONDE**  
by Théo

*'Edition volants recyclés'*  
Dimensions : 50x50x43cm  
12kg eq. CO2  
Prix HT : 215€



---

**TABLE D'APPOINT  
DUO DE PLATEAUX & BOL**  
by Diane

Dimensions : 50x50x43cm  
18kg eq. CO2  
Prix HT : 219€



---

**TABLE D'APPOINT  
DUO DE PLATEAUX & LAMPE**  
by Charlotte

Dimensions : 50x43cm  
27kg eq. CO2  
Prix HT : 269€



---

**TABLE D'APPOINT DUO**  
by Colette

Dimensions : 90x50x37cm  
20kg eq. CO2  
Prix HT : 229€



---

**TABLE D'APPOINT  
DUO & LAMPE**  
by Léonie

Dimensions : 90x50x37cm  
29kg eq. CO2  
Prix HT : 289€



---

**CAISSON**

Dimensions : 35,5x30x47cm  
17kg eq. CO2  
Prix HT : 199€



*'Édition volants  
de badminton  
recyclés'*





# MONTAGE & ENTRETIEN



Matériaux de **qualité**



Mobilier **meublant**



Nettoyage à l'**eau savonneuse**. Vernis acrylique alimentaire. **Résistance** produits alimentaires courants



**Montage simplifié**



Durée de vie prolongée. Meubles **réparables** & **pièces de rechange** à disposition. **Matériaux recyclables**

# ILS NOUS FONT CONFIANCE



Aujourd'hui, DIZY c'est 8 personnes dédiées à la conception, et au suivi de vos projets, mais aussi nos 20 partenaires fabricants et logistiques pour nous aider à délivrer parfaitement vos projets.



# NOTRE ÉCOSYSTÈME



LAURÉAT 2020  
Design & expérience client.

Entreprise



Certifiée





# Interrogez-nous !

Ce catalogue reprend un aperçu non-exhaustif de nos produits. C'est l'essence même de DIZY : créer des meubles uniques et durables pour vous !  
Notre équipe BtB est à votre écoute pour étudier votre projet et répondre à vos besoins.

**MBS**

[www.mbs95.com](http://www.mbs95.com)

**Aménageur d'Espaces**

[contact@mbs95.com](mailto:contact@mbs95.com)

**01 39 35 41 80**

**15 Rue de la Briqueterie  
95330 DOMONT**